

NTS8600 Series

Advanced SyncPro: IEC61850-3 HV & IEEE 1613 Certified NTP Server & IEEE 1588 PTP Grandmaster



FEATURED HIGHLIGHTS

- IEC 61850-3 HV & IEEE 1613 Certified NTP Server & IEEE 1588 PTP Grandmaster
- -40 to +85 °C Operating Temperature, IP30 Protection, and Up to 5100 m Altitude
- MIL-STD-810F Certified for Environmental and Transportation Reliability
- Dual Power Inputs: DC (Built-in) or AC (via Adapter) with Wide Input Range
- Full Redundancy Across Power, System, Network, and Link Layers
- <40 ns PRTC-B/PTP, <50 μs NTP Accuracy, Calnex Verified
- Excellent Holdover Performance: <0.5 μs/8 Hours / <72 μs/7 Days
- Supports Power, Telecom, AVBTSN and Enterprise Profile
- Three Ethernet Ports: Two PTP-Capable Combo Ports, All Three NTP-Capable
- Supports Power, Telecom Profiles, AVBTSN and Media Broadcast Profiles
- Dual Media Combo Ports Enable Cost-Effective Copper/Fiber Deployment
- Supports Multi-Constellation GNSS with Anti-Jamming and Anti-Spoofing
- Antenna Fault Detection and Protection: Short Circuit and Disconnection
- Configurable IRIG-B (TTL, AM, RS-485), PPS, and 10 MHz Outputs
- Compact design with rackmount and DIN-rail installation options
- Standard 5-Year Warranty, Upgradeable to 10 Years

PRODUCT DESCRIPTION

IEC 61850-3 HV & IEEE 1613 Certified NTP/PTP Grandmaster with -40 to +85 °C Operating Temperature

With an operating temperature range of -40 to +85 °C, and IEC 61850-3 HV and IEEE 1613 offering up to four times the EMC protection compared to rugged industrial-grade standards, the NTS8600 is engineered to operate reliably in environments exposed to electrical noise, temperature extremes, and radiated disturbances—ensuring uninterrupted performance and high system availability. The NTS8600 NTP Server and IEEE 1588 PTP Grandmaster is the world's first solution fully certified to both IEC 61850-3 HV and IEEE 1613 standards, delivering exceptional resilience and precision in demanding applications such as power substations, telecommunications networks, automation systems, and enterprise infrastructure.

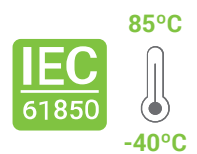

High Precision Timing

Rigorously tested by Calnex Solutions, a leader in network synchronization testing, the NTS8600 series delivers exceptional time precision, ensuring your power applications' synchronization needs are met with the highest standards of accuracy. Featuring proven PRTC-B accuracy within 40 ns, IEEE 1588 PTP accuracy within 40 ns, and NTP accuracy within 50 μs, this Grandmaster guarantees precise time distribution across your network.

Superior Holdover Performance

Holdover performance is critical to ensure uninterrupted and accurate time synchronization during loss of the primary time source. The NTS8600 series offers exceptional holdover stability, with a drift of less than 0.5 μs over 8 hours, and approximately 72 μs over 7 days, as validated by Calnex Solutions. When entering holdover mode, the system intelligently adjusts protocol attributes according to the active time profile (e.g., Power, Telecom), and proactively issues notifications via alarms and syslog to alert operators.





Versatile Profile Support and Upgradeability

The Grandmaster supports a wide range of IEEE 1588 PTP profiles, making it suitable for deployment in power, telecom, AVB/TSN, and enterprise networks. For power utilities, it complies with IEEE C37.238-2011, C37.238-2017, and IEC/IEEE 61850-9-3:2016. Telecom synchronization is supported through ITU-T G.8265.1, G.8275.1, and G.8275.2 profiles. IEEE 802.1AS is also supported for time-sensitive networking in industrial and media environments. The Enterprise profile ensures interoperability across standard IT infrastructures. In addition, the Grandmaster supports SyncE for enhanced frequency stability in telecom applications.

GNSS Vulnerability Mitigation and Antenna Protection

NTS8600 offers enhanced robustness and resilience against jamming and spoofing attacks. By receiving signals from multiple constellations for verification, the system can provide spoofing detection and enter holdover mode if necessary. The Grandmaster also features comprehensive antenna vulnerability mitigation, detecting short and disconnected antennas to maintain system integrity. For added protection, a surge protector is available for purchase, safeguarding your equipment from electrical surges and ensuring the reliability of your timing infrastructure.

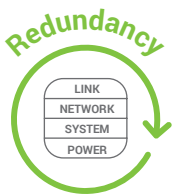

Comprehensive Redundancy

System redundancy is guaranteed by clustering featuring IEC 62439-3 Parallel Redundancy Protocol (PRP) to ensure network redundancy without data loss or downtime. Link redundancy is achieved through bonding, providing resilient connectivity. Additionally, NTS8600 series offers power redundancy options, including dual DC inputs or a combination of one DC and an external HVAC/HVDC power supply, to safeguard against power failures.

Flexible Timing Output

Modulated IRIG-B is ideal for long-distance transmission due to its resistance to signal degradation and compatibility with legacy equipment. Demodulated IRIG-B, available in TTL or RS-485 formats, offers higher precision, with IRIG-B RS-485 supporting distances up to 1200 meters. PPS and 10MHz outputs are crucial timing signals in modern IEC 61850 power applications, providing precise synchronization essential for various grid operations. The NTS8600 series features up to six configurable outputs, including IRIG-B TTL, AM, RS-485, 1-PPS, and 10MHz waveform. Additionally, IRIG-B RS-485 can be extended over long distances using the ATOP SF63 serial-to-fiber converter via fiber-optic cable.

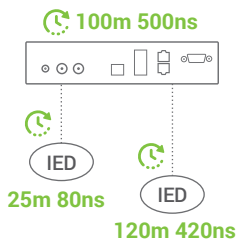
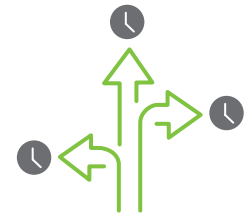

Ensuring Precision with Comprehensive Delay Compensation

Compensation for antenna delay is essential because long antenna cables can introduce timing errors that affect the accuracy of synchronized operations. Similarly, output delay compensation for signals such as IRIG-B and PPS is vital, especially in systems with multiple IEDs connected. It is much easier and more efficient to compensate for cable delays at the Grandmaster level rather than at each individual IED, as not all IEDs support delay compensation. Handling these adjustments centrally at the Grandmaster guarantees that all connected devices operate in perfect sync, optimizing the performance and coordination of critical substation operations.

APPLICATION CASE

IEEE 1588 in Power Networks: Precision Time Synchronization and Time Redundancy

Two NTS8600 units in the station layer determine the Active and Backup GMC through BMCA. The Active GMC synchronizes to both GPS and GNSS satellite systems and transmits via IEC 62439-3 PRP to two power domains composed of PRP and HSR networks. According to IEC 61850-9-3 and IEEE C37.238-2017, the total end-to-end budget is 1us, with GMC being 250ns. The NTS8600 achieves superior accuracy of <40ns, reserving more budget for other devices. For early MU devices that rely on 1PPS or IRIG-B for synchronization, the NTS8600 offers 1PPS, IRIG-TTL, IRIG-B AM, IRIG-B RS-485, and RS-485 to fiber-optics by SF-63 for long-distance transmission and delay compensation.

The HSR network provides zero-packet-loss redundancy but also increases latency. Devices in the process layer require more precise timing. When the end-to-end budget cannot be met, a GMC must be deployed to aid in accurate timing for critical devices. The NTS8600, certified to IEC61850-3 HV & IEEE 1613, operates reliably in harsh process layer environments, providing precise synchronization.

In addition to the NTS8600, our timing solution for power substations also includes BC or TC of RHG9728 and RHG9528, P-Delay TC of EH9711, HSR Redbox, and Quadbox of RGB700X. Check our website for more detailed information on these products

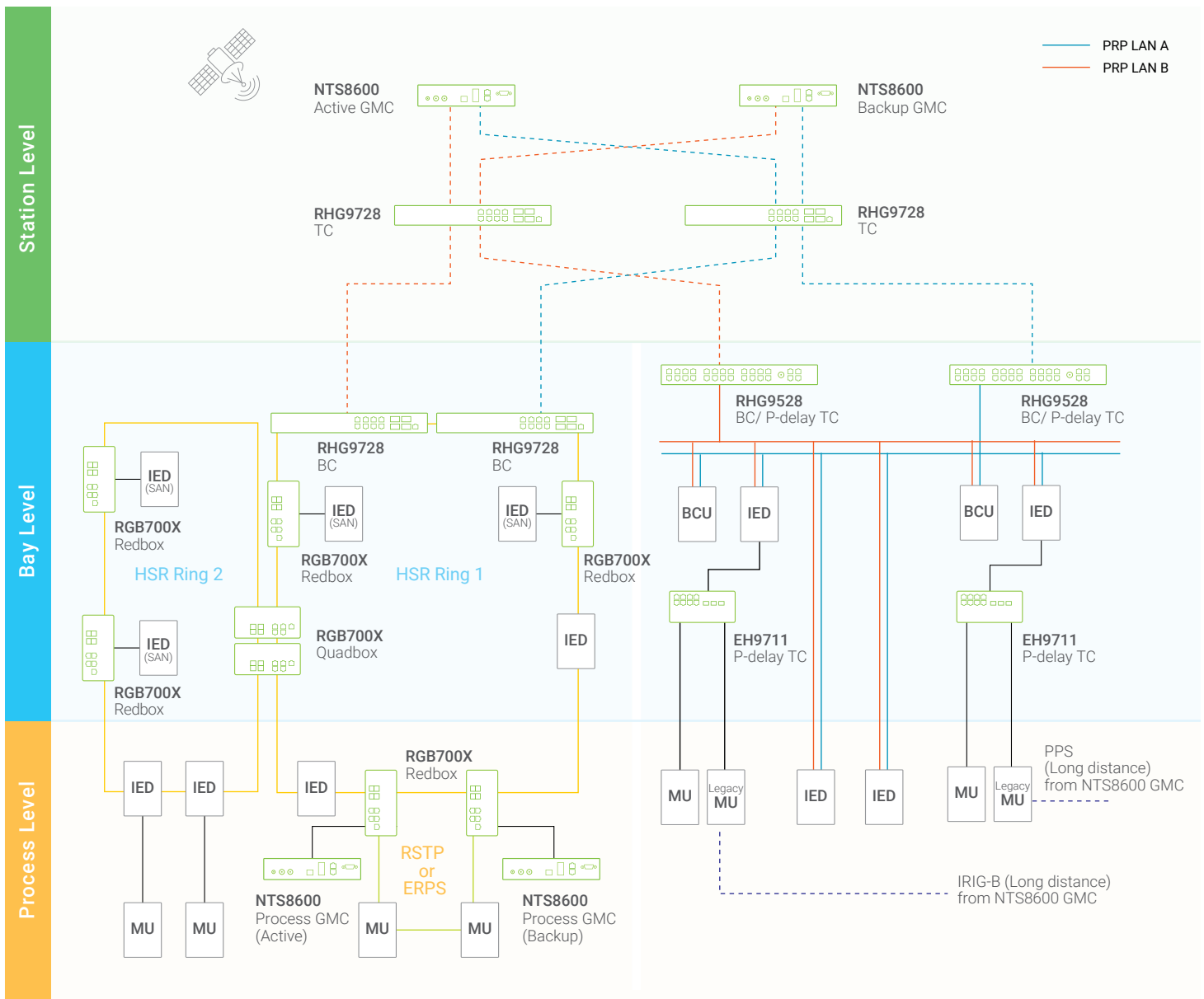

CONNECTORS

Front View – NTS8600 (All models)

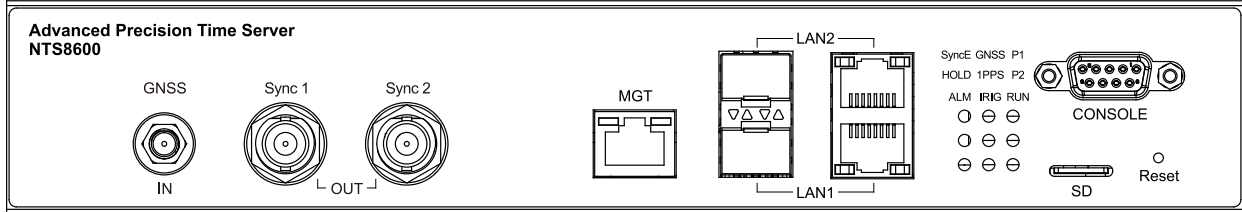

Back View – NTS8600-DC

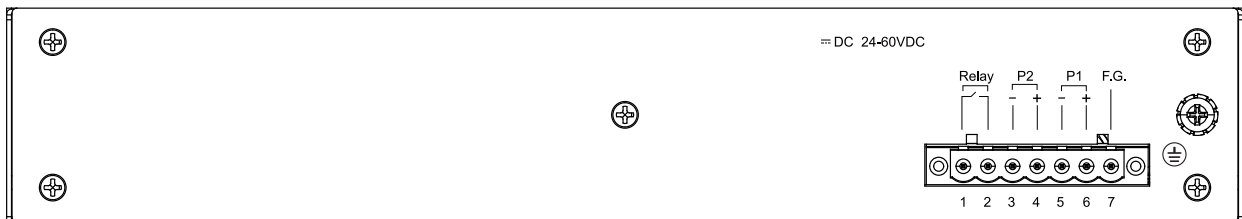

Back View – NTS8600-AC

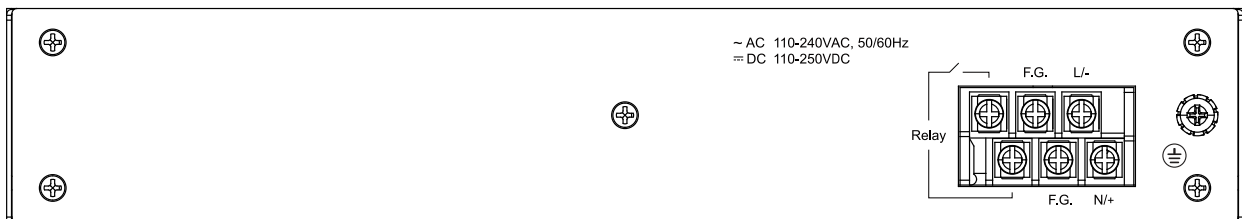

Back View – NTS8600I-DC

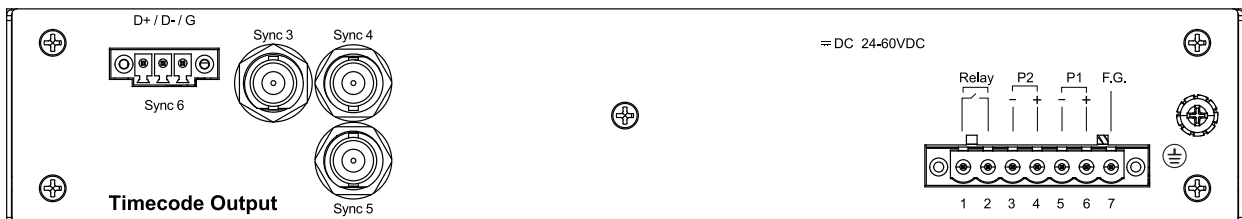

Back View – NTS8600I-AC

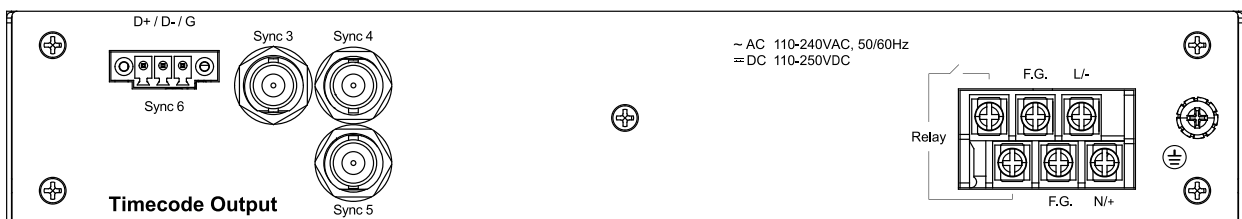

DIMENSIONS & LAYOUT

Front View

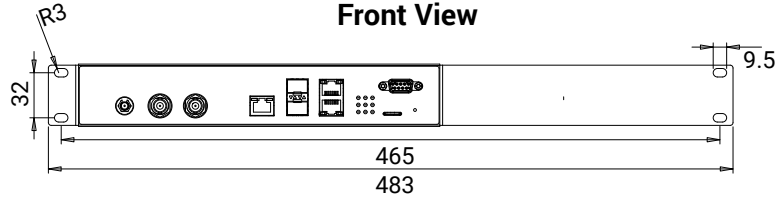

Side View

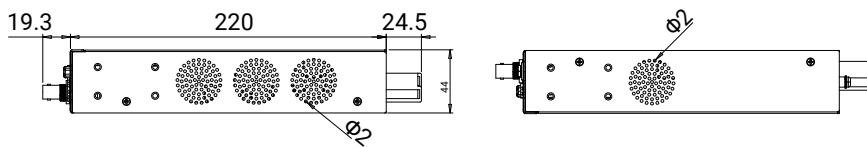

Back View

NTS8600-AC

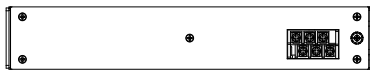

NTS8600-DC

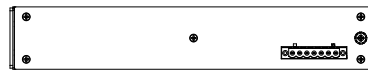

NTS8600I-AC

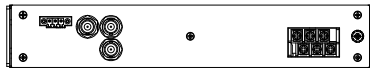

NTS8600I-DC

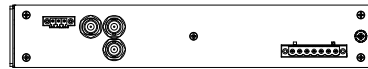

Top View

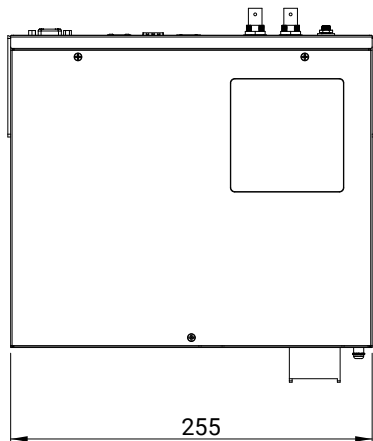

Rackmount Installation View

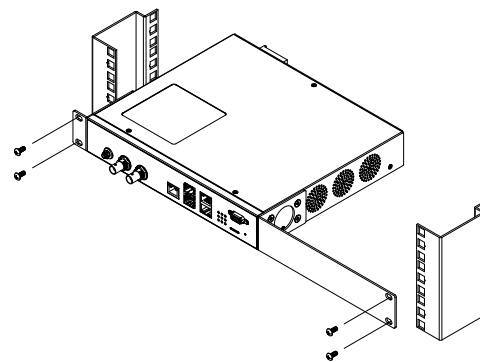

unit: mm

SPECIFICATIONS

Technical Specifications	
Model Name	NTS8600/NTS8600I Series
GNSS Receiver Specifications	
GNSS Input ports	1x GNSS Input; SMA (F) - active Antenna
GNSS Module specific Information	Multi-Constellation Supported: GPS L1, GLONASS L1, BeiDou B1, Galileo E1 Maximum Concurrent Constellations: 3 Leap Second: Supported Sensitivity for GPS: <ul style="list-style-type: none"> • Tracking: -166 dBm • Reacquisition: -160 dBm • Cold Start: -148 dBm • Hot Start: -160 dBm
Acquisition Times	Cold Start: < 45 seconds Warm Start: < 7 seconds
Antenna Requirements	3.3 V, < 50 mA Minimum gain=5dB; Maximum gain + Cable Attenuation ≤ 40dB
GNSS Vulnerability Mitigation	Jamming Support Detection, Warning and Switch to OCXO Holdover
	Spoofing Support Detection, Warning and Switch to OCXO Holdover (GNSS Antenna Only)
Antenna Vulnerability Mitigation	Antenna Cable Short Support Detection, Warning and Switch to OCXO Holdover Mode
	Antenna Disconnection Support Detection, Warning and Switch to OCXO Holdover Mode
Antenna specification (Accessories)	
GNSS Antenna (70100000000090G)	GNSS receiver: GPS L1, GLONASS L1, BeiDou B1, Galileo E1 LNA Gain: 40dB min Weather-Proof Housing: IP69K Operating and Storage Temperature: -40°C ~85°C ESD: ±15KV Air Discharge Mechanical size: 66.5 mm dia. x 21 mm H MIL-STD-810F Supply Voltage Range: 2.5 to 16VDC
GPS Antenna (70100000000091G)	GNSS receiver: GPS L1, Galileo E1 LNA Gain: 40dB min Weather-Proof Housing: IP69K Operating and Storage Temperature: -40°C ~85°C ESD: ±15KV Air Discharge Mechanical size: 66.5 mm dia. x 21 mm H MIL-STD-810F Supply Voltage Range: 2.5 to 16VDC
Anti-Jamming GNSS Antenna (70100000000098G)	GNSS Receiver: GPS L1, GLONASS L1, BeiDou B1, Galileo E1 LNA Gain: 40dB typ. Weather-Proof Housing: IPX7 Operating and Storage Temperature: -40°C - 85°C ESD: ±15KV Air Discharge Mechanical Size: 100 mm dia. x 102 mm H MIL-STD-810F Supply Voltage Range: 2.5 to 16VDC

Maximum Antenna Cable Length	Antenna cable: Without amplifier: LMR-400: 150M CFD-240: 100M CFD-200: 50M RG58A/U: 25M With Amplifier: LMR-400: 250M CFD-240: 100M CFD-200: 80M RG58A/U: 50M
Maximum Sync-Out Cable Length	RG58 A/U Sync-Out cable: 1PPS, 10MHz, IRIG-B TTL: 150M IRIG-B AM: 150M @ 1K impedance , 300M @ 10K impedance IRIG-B RS485: 1200M IRIG-B RS-485 with SF63 Fiber optic 2KM
Proven Clock Accuracy (Relative to UTC)	
1PPS	±40 ns Peak *1
Demodulated IRIG-B	±40 ns Peak *1
Modulated IRIG-B AM	±1 µs Peak *1
RS-485 IRIG-B	±100 ns Peak *1
PTP Timestamp	±40 ns Peak *1
NTP Timestamp	±50 us Peak , ±40 us Average *1
Holdover accuracy - OCXO	< 0.5 us / 8 hours / < 72 us / 7 days *2
*1. Device locked to satellites for at least 24 hours. *2. Device locked to satellites for at least 48 hours before holdover	
Network Interface	
Ethernet Standards	IEEE 802.3 10BaseT IEEE 802.3u 100BaseT(X) IEEE 802.3ab for 1000BaseT(X) IEEE 802.3u for 100Base-FX IEEE 802.3z for 1000Base-X
Gigabit Ethernet Ports	Two Combo ports, 2x 10/100/1000BASE-T(X) RJ45 or 2x 100/1000 Base-X SFP Support Synchronous Ethernet (SyncE) per ITU-T G.8261 ITU-T, G.8262 and G.8264 ESMC), PTP-Capable and NTP-Capable
Management Port	1x 10/100 BASE-T(X) RJ45, NTP-Capable
I/O	
Console	1x DB9 Serial Console Port
SD slot	1x micro-SD slot
Relay - Alarm Contact	Rated Operational Voltage: 24 VDC Continuous carrier: 1A Normal Open Pickup time: 2.5ms Turn-off time: 1ms
Sync Module – S1 (Applied for NTS8600)	
Sync 1, Sync 2	Two configurable output channels (coaxial BNC (F) connector): 1. 10MHz (Square Wave) 2. 1PPS/PPM/PPH Output (Square Wave, configurable pulse width) 3. IRIG-B TTL (Support IEEE1344 and C37.118.1) 4. AFNOR French Time Code 5. BCD, BJT, ST and ST Checksum (Contact sales for these timecodes)
Sync Module – S2 (Applied for NTS8600I)	
Sync 1, Sync 2	Two configurable output channels (coaxial BNC (F) connector): 1. 10MHz (Square Wave) 2. 1PPS/PPM/PPH Output (Square Wave, configurable pulse width) 3. IRIG-B TTL (Support IEEE1344 and C37.118.1) 4. AFNOR French Time Code 5. BCD, BJT, ST and ST Checksum (Contact sales for these timecodes)

Sync 3 ~ Sync 6	<p>Three extra configurable output channels (Sync 3 ~ Sync 5, coaxial BNC (F) connector):</p> <ol style="list-style-type: none"> 10MHz (Square Wave) 1PPS/PPM/PPH Output (Square Wave, configurable pulse width) IRIG-B TTL B000~B007 (Support IEEE1344 and C37.118.1) IRIG-B AM B120~B127 (Support IEEE1344 and C37.118.1) AFNOR French Time Code BCD, BJT, ST and ST Checksum (Contact sales for these timecodes) <p>One extra standalone channel (Sync 6, TB3 connector)</p> <ol style="list-style-type: none"> IRIG-B RS-485 B000~B007 (Support IEEE1344 and C37.118.1) 	
Electrical Output Drive Levels		
1PPS	5VDC 20 mA TTL compliant	
IRIG-B TTL	5VDC 20 mA TTL compliant	
Modulated IRIG-B	5Vp-p, 3.3:1 ratio, AM, Sinewave	
IRIG-B RS485	±5 VDC IRIG-B Half-Duplex; 32 Transceivers Max. a bus	
Frequency		
Oscillator	Advanced managed OCXO, with temperature drifting compensation	
IEEE1588 Profiles		
Default	<p>IEEE 1588V2 (PTPv2)</p> <p>Default UDP (IEEE1588-2008 Annex D and J)</p> <p>Default 802.3 (IEEE1588-2008 Annex F and J)</p>	
Power	<p>IEC/IEEE61850-9-3-2016 Power Utility Profile</p> <p>IEEE C37.238-2011 Power Profile, with VLAN support</p> <p>IEEE C37.238-2017 Power Profile, with VLAN support</p>	
Telecom	<p>ITU-T G.8265.1 Frequency</p> <p>ITU-T G.8275.1 Phase/Time</p> <p>ITU-T G.8275.2 Phase/Time</p>	
AVBTSN	802.1AS Profile	
Enterprise	Enterprise Profile	
Media Broadcast	<p>AES67 Media Profile (Ready)</p> <p>SMPTE ST 2059-2 (In Development Plan)</p>	
System Modes		
GNSS Locked Mode	Synchronizes time with GNSS signals for high accuracy	
Holdover Mode	Maintains time using the OCXO clock after GNSS is unavailable	
Free Run Mode	Operates independently using RTC as the time source along with the OCXO clock.	
Boundary Clock Mode	Synchronizes to an upstream PTP master and distributes PTP time downstream.	
APTS Mode	Provides alternate PTP time-source support when GNSS is unavailable.	
Functions & Protocols		
Protocols	Network Synchronization	<p>RFC 1119 (NTPv2) Server</p> <p>RFC 1305 (NTPv3) Server</p> <p>RFC 5905 (NTPv4) Server</p> <p>RFC 1769 (SNTPv3) Server</p> <p>RFC 2030 (SNTPv4) Server</p>
	Network Protocols	<p>VLAN (IEEE 802.1q) filtering/tagging</p> <p>IEEE 802.1p QoS</p> <p>DSCP</p> <p>IPv4, IPv6</p> <p>TCP, UDP</p> <p>DHCP Client</p> <p>TACAS+ / RADIUS</p>

Protocols	Redundancy	Devices Clustering (NTP Only) PRP (IEC 62439-3) Bonding – Active & Backup Bonding – LACP Combo Ports
	Management	HTTP, HTTPS SNMP v1/v2,v3 SSH/ Telnet (CLI), could be enabled/disabled Console CLI Estimated Time Accuracy GNSS Status Power Status PTP & NTP Status SD/MMC Backup & Restore
	Event & Alarm	Event Log Syslog Relay & Alarm Management SNMP Trap
Physical Characteristics		
Housing Dimension (W x H x D) Weight Installation	SPCC w/Zinc Plated Body + Aluminum cover IP30 Metal Housing 252.8 x 220 x 44 2KG (AC + IRIG-B) / 1,9KG (DC + IRIG-B) 1U Rack-mountable or DIN-Rail Kits (Optional)	
Power Supply		
Rated Supply Voltage	110 – 240 VAC, 50/60HZ (NTS8600 AC series) 110 – 250 VDC (NTS8600 AC series) 24 – 60 VDC (NTS8600 DC series)	
Input Voltage Range	85 – 264 VAC, 50/60 HZ (AC series) 88 – 300 VDC, (AC series) 19 – 66 VDC, (DC series)	
Power Consumption	Approximately 9.4 W (Max)	
Environmental Limits		
Operating Temperature Storage Temperature Operating Altitude Ambient Relative Humidity	-40°C to +85°C (-40°F to 185°F) -40°C to +85°C (-40°F to 185°F) 5100m 5% to 95% (Non-condensing)	

REGULATORY APPROVALS

Regulatory Approvals				
Safety	UL 62368-1 , CB IEC62368-1/EN62368-1 (UL Certified Operating Temperature: 75°C)			
EMC	FCC(EMI): FCC Part 15, Subpart B, Class A CE(EMI): EN 55032, EN61000-6-4, Class A EN 61000-3-2 (Current Harmonics) EN 61000-3-3 (Voltage Flicker) CE(EMS): EN 55035, EN61000-6-2 CE(GNSS): EN 303 413. EN 301 489-19			
Power Automation	IEC61850-3, IEEE 1613			
Test	Item	Value	Level	
IEC 61000-4-2	ESD	Contact Discharge	±8KV	4
		Air Discharge	±15KV	4
IEC 61000-4-3	RS	Enclosure Port	10(V/m), 80-3000MHZ 20(V/m), 80-1000MHZ	3
IEC 61000-4-4	EFT	AC Power Port	±4.0KV	4
		DC Power Port	±4.0KV	4
		Signal Port	±2.0KV	Special
IEC 61000-4-5	Surge	AC Power Port	Line-to Line±2.0kV Line-to Earth±4.0kV Line-to Line±1.0kV Line-to Earth±2.0kV Line-to Earth±4.0kV	4
		AC Power Port		4
		DC Power Port		4
		DC Power Port		3
	Signal Port	4		
IEC 61000-4-6	CS	0.15-80MHZ	10V rms 0.15-80MHZ, 80% AM	3
IEC 61000-4-8	PFMF	(Enclosure)	100A/m continuous, 1000A/m (3s)	5
IEC 61000-4-11	DIP	AC Power Port	30% reduction (Voltage Dips), 1 period 60% reduction (Voltage Dips), 50 period 100%, reduction (Voltage interruptions), 5 period 100% reduction (Voltage interruptions), 50 period	-
IEC 61000-4-16	Main Frequency Voltage	DC Input Port	30V Continuous, 300V 1s	4
		Signal Port	30V Continuous, 300V 1s	4
IEC 61000-4-17	Ripple	DC Input Port	10% of unit	3
IEC 61000-4-18	Damped Oscillatory	AC Power Port	2.5KV common, 1KV differential mode @ 1MHz	3
		Signal Port Telecommunication Port	2.5KV common, 1KV differential mode @ 1MHz	3
IEC 61000-4-29	DC Voltage Dips & Interruptions	DC Input Port	30% Reduction (Voltage Dips):0.1 sec 60% Reduction (Voltage Dips):0.1 sec 100% Reduction (Voltage Interruption):0.05 sec	
Shock Drop Vibration	MIL-STD-810G Method 516.5 MIL-STD-810F Method 516.5 MIL-STD-810F Method 514.5 C-1 & C-2			
RoHS2	Yes			
MTBF	20 years			
Warranty	5 years / Upgradable to 10 years			

ORDERING INFORMATION

Main core and Modules

Model Name	Part Number	Ethernet Port	Sync Module	Input Voltage Range
NTS8600-DC	1P1NTS86000001G	1 x 10/100 MGMT RJ45 port and 2 x 10/100/1000 RJ45/SFP combo ports	S1	Dual 19-66 VDC
NTS8600-AC	1P1NTS86000002G			Single 85-264 VAC or 88-300 VDC*
NTS8600I-DC	1P1NTS8600I001G		S2	Dual 19-66 VDC
NTS8600I-AC	1P1NTS8600I002G			Single 85-264 VAC or 88-300 VDC*

* NTS8600 Dual AC input can be achieved using two external SDR-75-24 power supplies or by selecting the NTS8610 model.

• Refer to the [NTS86X0 Selection Guide](#) for product differences.

Optional Accessories – Antenna, Amplifier, Surge Protector and Mounting Kits

Model name	Part Number	Description
GNSS Antenna Package	70100000000090G	This package includes 1. High Gain Multi-Constellation TNC-Female Antenna (See the Antenna Specifications section above for a spec summary) 2. 2 meters SMA Male to TNC Female antenna cable
GPS Antenna Package	70100000000091G	This package includes 1. High Gain GPS L1 TNC-Female Antenna (See the Antenna Specifications section above for a spec summary) 2. 2 meters SMA Male to TNC Female antenna cable
Anti-Jamming GNSS Antenna	70100000000098G	This package includes 1. High Gain Anti-Jamming Multi-Constellation TNC-Female Antenna (See the Antenna Specifications section above for a spec summary) 2. 2 meters SMA Male to TNC Female antenna cable
RF Amplifier	70100000000092G	Inline TNC-Female to TNC-Female RF (1559-1610MHz) Amplifier 25dB with supply volts 3-10 VDC and 10mA including One TNC Male to TNC Male adapter
Surge Protector	70100000000093G	SOCAA 4LTJ10TP001 – TNC-Female to TNC-Male 10KA Surge protection device including One TNC Female to TNC Female adapter
Advanced Surge Protector	70100000000094G	Phoenix Contact CN-UB-280DC-BB – N-Type 20 KA Surge protection device including two N-type Male to TNC Female adapter
Mounting Kits	70100000000095G	The antenna mounting kit includes an L-bracket, mount adapter and ground plane. (See NTS8600 Accessories Guide for more details)
DIN Rail Mounting Kit	70100000000103G	Enables secure and convenient installation on standard DIN rails.
TNC M to M Adaptor	59902971G	TNC Male to Male Adaptor
TNC F to F Adaptor	59902981G	TNC Female to Female Adaptor

Optional Accessories – Antenna and Sync-Out Cables

Model name	Part Number	Description
Antenna Cable RG58	Made to Order	TNC-Male to TNC-Male RG58 Antenna Cable. Maximum RG58 Antenna Cable Length: 25m
Antenna Cable CFD-200	Made to Order	TNC-Male to TNC-Male CFD-200 Antenna Cable. Maximum CFD-200 Antenna Cable Length: 50m
Antenna Cable CFD-240	Made to Order	TNC-Male to TNC-Male CFD-240 Antenna Cable. Maximum CFD-240 Antenna Cable Length: 100m
Antenna Cable LMR-400	Made to Order	TNC-Male to TNC-Male LMR-400 Antenna Cable. Maximum LMR-400 Antenna Cable Length: 150m Maximum LMR-400 Antenna Cable Length with RF Amplifier: 250m
Sync-Out Cable (IRIG-B/PPS TTL)	Made to Order	BNC-Male to BNC-Male Custom-Length RG58 Antenna Cable. Specify desired length when ordering. Supports up to 150 m.

Optional Accessories – SFP Modules

Model name	Part Number	Description
AXFD-1314-0523	522AXFD1314001G	SFP Transceiver, 155Mbps, 1310nm, multi-mode, 2km, -40°C to +85°C, DDMI
AXFD-1314-0553	522AXFD1314011G	SFP Transceiver, 155Mbps, 1310nm, single-mode, 30km, -40°C to +85°C, DDMI
AXGD-5854-0513	522AXGD5854001G	SFP Transceiver, 1250Mbps, 850nm, multi-mode, 550m, 3.3V, -40°C to +85°C, DDMI
AXGD-1354-0523	522AXGD1354001G	SFP Transceiver, 1250Mbps, 1310nm, multi-mode, 2km, 3.3V, -40°C to +85°C, DDMI
AXGD-1354-0533	522AXGD1354011G	SFP Transceiver, 1250Mbps, 1310nm, single-mode, 10km, 3.3V, -40°C to +85°C, DDMI
AXGD-3354-0593	522AXGD3354001G	SFP Transceiver, 1250Mbps, 1310nm, single-mode, 40km, 3.3V, -40°C to +85°C, DDMI

Optional Accessories – External Power Adapter and Converter

Model name	Part Number	Description
SDR-75-24	50500752240001G	DIN RAIL POWER SUPPLY / T; 88~264VAC/ 124~370VDC to 24VDC 3.2A; 75W
SF63 Series	See ATOP SF63 Datasheet	Industrial Serial to Fiber Media Converter for long distance transmission