



ATOP Technologies, Inc.

**Redundancy Gigabit Box
IEC61850-3 HSR/PRP Managed Switch**

RGB700X Series

Hardware Installation Guide

Version 1.1

Updated in November, 2025



Package Check List

Inside the package you will find the following items

- Industrial Managed Gigabit Ethernet Switch x 1
- 3-Pin 5.08mm Lockable Terminal Block (already mounted to the device) x 1
- 4-Pin 5.08mm Lockable Terminal Block (already mounted to the device) x 1
- 5-Pin 5.08mm Lockable Terminal Block (already mounted to the device) x 1
- DIN-Rail Kit (already mounted to the device) x 1
(Din Rail Screw Type: M3 / Screw Depth: Max. 6 mm / Screw Qty: 4 pcs)
- Protective Caps for All SFP Ports (depend on purchased model)
- Installation Guide with Warranty Card x 1

If using optical transceivers to connect to SFP+ or QSFP connectors, only CDRH certified laser class I optical transceivers shall be used.

- ⚠ Never install or work on electricity or cabling during periods of lightning activity. Never connect or disconnect power when hazardous gases are present.
- ⚠ Warning: Hot Surface. Do Not Touch. RESTRICTED ACCESS AREA: The equipment should only be installed in a Restricted Access Area.
- ⚠ Caution: CLASS 1 LASER PRODUCT. Do not stare into the laser!
- 🏠 This equipment should be installed indoor and do not connect directly with equipment installed outdoor.

Product Layout

Top View

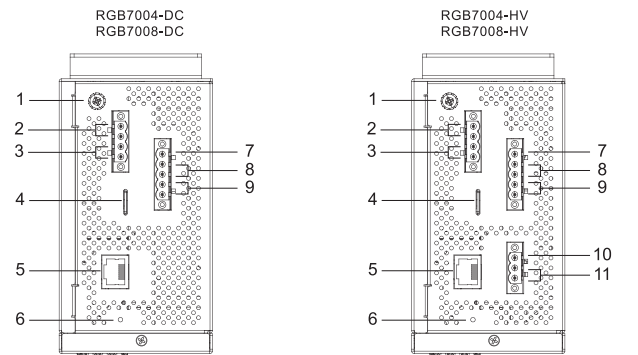

- | | |
|---|---|
| 1. Grounding Screw | 8. Power Input for Power 1 (For DC1 input) |
| 2. Digital Input | 9. Power Input for Power 2 (For DC2 input) |
| 3. Relay Output with current carrying capacity of 1A @ 24 VDC | 10. Frame Ground (For HV/AC input) |
| 4. SD-card Slot | 11. Power Input for Power 3 (For HV/AC input) |
| 5. RS-232 Console | |
| 6. Reset Button | |
| 7. Frame Ground | |

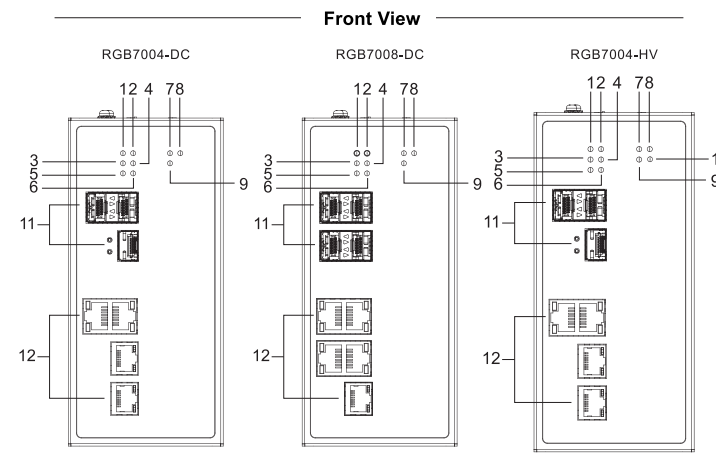

- | | |
|------------|----------------|
| 1. RUN | 10. P3 |
| 2. ALM | 11. SFP Ports |
| 3. PRP | 12. RJ45 Ports |
| 4. HSR | |
| 5. HSR-PRP | |
| 6. HSR-HSR | |
| 7. P1 | |
| 8. P2 | |
| 9. DI | |

Installation Overview

The device's appearance is as in the figure below.

1. If you have purchased the wall mount kit, please remove the mounted DIN-Rail kit before proceeding to place the screws on the back of the device as shown in (Fig. 1).

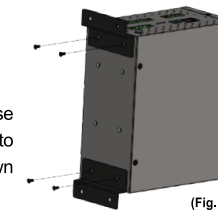

Wall-Mount Screw Type: M3 / Screw Depth: Max. 6 mm / Screw Qty: 4 pcs

2. Although internal grounding has been done inside, in order to ensure overall maximum performance and protect your device, it is still strongly advised to ground the device properly; hazardous ESD can come into contact and damage your equipment. On the power terminal block, there is a terminal for Frame Ground; grounding screw next to the terminal block (the one chosen should be connected at all times). (Fig. 2 & Fig. 3)

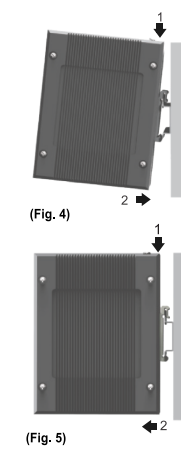
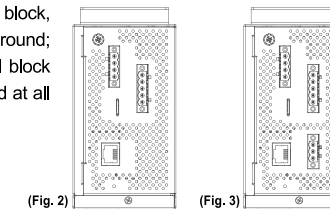

3. You can then choose whether to plug in the other peripheral ports at this point or do it later depending on the actual location of the device or level of comfort for performing such operation.
Remember to plug in the protective caps for the unused SFP.
4. Once the plate has been firmly put in place, proceed to mount the whole device as shown in (Fig. 4). Proceed to (Fig. 5) if you want to remove the device from DIN-Rail.
5. Next we can then proceed to connect the device to the LAN (switch or PC, depending on the case), take care on using the RJ-45 connector; after this we can then proceed to the device's settings.

- The openings on the sides are for the device's heat dissipation. Never obstruct or cover them with any objects or try to insert items through it.
- The default IP for this switch is 10.0.50.1. You can access the device by its Web UI once it is connected to a physical network or using Management Utility (for more information, please refer to Management Utility's manual). Please be aware that the PC needed for this procedure needs to be in the same subnet, otherwise please refer to the device's User Manual.

Power Requirements

- Power input : 12-48 VDC
110-240 VAC (for AC Input)
110-300 VDC (for HV Input)
- The power input for AC and HV is the same. Refer to top view item 11 and 12.
- Relay Output : Relay Output with current carrying capacity of 1A@24 VDC. (Normal Open)
All circuits shall be connected to SELV circuit
- The DC supply source for the equipment power supplied shall be an certified power source and suitable for specification, rated 12-48 Vdc, 1.5A minimum, Tma 85 degree C minimum or 110-300Vdc, 0.15A minimum provided by the manufacturer.

CAUTION: Double pole, neutral fusing. Disconnect mains before serving.

This equipment should be installed indoor by Skill person and do not connect directly with equipment installed outdoor.

To connect AC mains

1. Turn OFF AC mains from the building's branch circuit breaker and from the equipment.
2. Ensure that AC mains is connected to the building's earthed cable.
3. Only use an earthed cable (AWG14 min. green-and-yellow wire) to connect the AC mains to the AC IN connector.
4. Connect signal cables to the equipment.
5. Ensure all terminals are correct, then connect the power cable to the equipment.
6. Connect the power cable to the terminal block of AC mains.
7. Turn ON AC mains from the building's branch circuit breaker and from the equipment.

To Disconnect AC mains

1. Turn OFF AC mains from the building's branch circuit breaker and from the equipment.
2. Disconnect the power cable from AC mains and the equipment.
3. Remove the signal cables from the connectors.

Before powering on the device, the Functional Ground (Grounding Screw) must be connected to the ground.

Place the power cord where it can be easily disconnected.

Use an earthed cable (AWG 14 min. green-and-yellow wire) to connect building earth to the protective bonding earthed terminal of the equipment.
CAUTION, SHOCK HAZARD. TO DISCONNECT POWER, REMOVE ALL POWER CORDS FROM UNITS.

Connection for HVDC power source

Attention: Only trained service personnel are authorized to install and remove the 110-300 V dc power source, and make the connections to and disconnections from the 110-300 V dc power source and earth connection. The customer is responsible for ensuring that only trained service personnel install or remove the 110-300 V dc power cable and earth connection.

To Connect Power Source

Note:

- The HVDC power source for the equipment power supplied shall be an UL certified power source and suitable for specification provided by the manufacturer.
- Please use the jacketed power cable with 300 Volt, 14 AWG or 16 Amp min. to connect between the equipment and the DC power source.

1. Turn OFF HVDC power source and equipment that is to be connected to this product.
2. Ensure HVDC power source is connected to an earthed cable.
3. Connect the earthed cable (AWG14 min. green-and-yellow wire) from earth of building to the protective earthed terminal of the equipment.
4. Connect signal cables to the product.
5. Connect power cable to the product.
6. Ensure correct polarity of 110-300 V dc connections: 110-300 V dc is + and RTN is -.
7. Turn ON the HVDC power source.

To Disconnect Power Source

1. Turn OFF HVDC power source and equipment.
2. Disconnect the power cable from equipment.
3. Remove the signal cables from the connectors.
4. Remove the earthed cable from the protective earthed terminal of the equipment.

Pin Assignments and Connections

1G/100/10BASE-T RJ-45 Ethernet, PoE, and RS-232 Console Pinouts

RJ-45								
10/100BASE-T(X)								
Pin	1	2	3	4	5	6	7	8
Signal	TD+	TD-	RD+			RD-		
1GBASE-T								
Pin	1	2	3	4	5	6	7	8
Signal	BI_DA+	BI_DA-	BI_DB+	BI_DC+	BI_DC-	BI_DB-	BI_DD+	BI_DD-
RS-232 Console								
Pin	1	2	3	4	5	6	7	8
Signal			Tx	GND	GND	Rx		

100/1000/10G BASE-X Fiber Optic SFP Slot

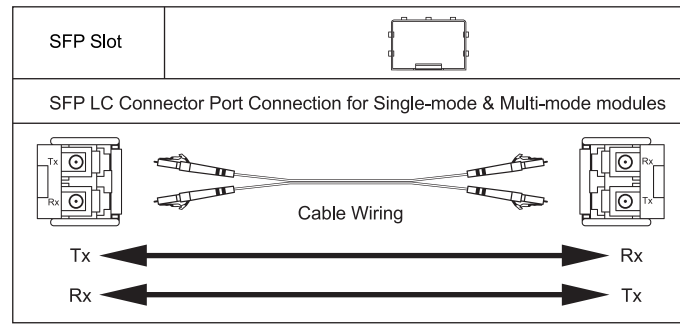

Caution
The SFP slot should be used in conjunction with a MSA compliant optical transceiver.

LED Indicators

LED	Color	State	Description
P1 P2 P3	Green	On	Power is being supplied through this power input
		Off	Power is not supplied through this power input
ALM	Red	On	Alarm is triggered by user defined events
		Off	Alarm is not triggered
RUN	Green	Blinking	Switch firmware is running normally
		Off	System is not ready or halted
PRP	Green	On	PRP-SAN is active
		Off	PRP-SAN is off
HSR	Green	On	HSR-SAN is active
		Off	HSR-SAN is off
HSR-PRP	Green	On	HSR-PRP is active
		Off	HSR-PRP is off
HSR-HSR	Green	On	HSR-HSR is active
		Off	HSR-HSR is off
DI	Green	On	Status is closed
		Off	Status is opened.
100/1000 SFP	Amber	On	Ethernet is linked at 1000Mbps
		Blinking	Ethernet is linked at 100Mbps
	Green	On	Ethernet is linked
		Blinking	Ethernet is active and data is being transmitted
LAN	Amber	On	10/100Mbps link, No 10/100Mbps activity
		Blinking	10/100Mbps link, 10/100Mbps activity
		Off	No 10/100Mbps link
	Green	On	1000Mbps link, No 1000Mbps activity
		Blinking	1000Mbps link, 1000Mbps activity
		Off	No 1000Mbps link

Environmental Limits

- Operating Temperature: -40°C to +85°C (-40°F to +185°F)
Operating Temperature(LVD): -40°C to +75°C (-40°F to +167°F)
- Storage Temperature: -40°C to +85°C (-40°F to +185°F)
- Ambient Relative Humidity: 5% to 95% (Non-condensing test @ 55°C)
- Altitude: 5,000 m

Mechanical Dimensions (Unit=mm)

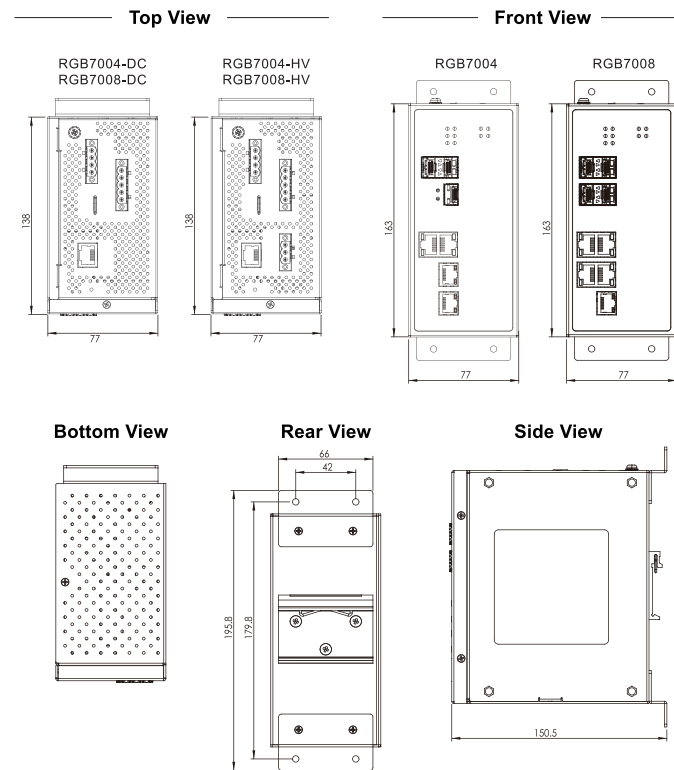

* The wall mount kit illustrated in this document is for reference only and is not included in the package.

Field Maintenance and Service

If the device requires servicing of any kind, you may need to disconnect and remove it from its mounting. The initial installation should be done in a way that makes this as convenient as possible.

- Voltage/Power lines should be properly insulated as well as other cables. Be careful when handling so as to avoid tripping.
- Do not under any circumstance insert foreign objects of any kind into the heat dissipation holes located on the surface of the device. This may not only harm the internal layout but might cause harm to you as well.
- Do not under any circumstance open the device for any reason. Please contact your dealer for any repair needed or follow the instructions of your User Manual.

Attention

1. It is recommended to use at least 20 AWG cable and the cable needs to be resistant to at least 85°C on the power connector.
2. Torque applied to the Terminal block's screw should be 4.5 in. lb (0.51 Nm).
3. The device needs to be installed inside a Type 1 housing.
4. The device needs to be installed in an area of pollution degree 2 or less.
5. If the equipment is used in a manner not specified by the manufacturer, the protection provided by the equipment may be impaired.
6. Clean the device with a soft dry cloth.

Warranty Policy

Warranty Conditions

Products supplied by ATOP Technologies are covered in this warranty for sub-standard performance or defective workmanship. The warranty is not, however, extended to goods damaged in the following circumstances:

- (a) Excessive forces or impacts
- (b) War or an Act of God: wind storm, fire, flood, electric shock, earthquake
- (c) Use of unqualified power supply, connectors, or unauthorized parts/kits
- (d) Replacement with unauthorized parts

RMA and Shipping Costs Reimbursement

Customers shall always obtain an authorized "RMA" number from ATOP before shipping the goods to be repaired to ATOP. When in normal use, a sold product shall be replaced with a new one within 3 months after purchase. The shipping cost from the customer to ATOP will be reimbursed by ATOP.

After 3 months and still within the warranty period, it is up to ATOP whether to replace the unit with a new one; normally, as long as a product is under warranty, all parts and labor are free of charge to the customers.

After the warranty period, the customer shall cover the cost for parts and labor. Three months after purchase, the shipping cost from the customer to ATOP will not be reimbursed, but the shipping cost from ATOP to the customer will be paid by ATOP.

Limited Liability

ATOP shall not be held responsible for any consequential losses from using ATOP's product.

Warranty Period

Product Categories	Warranty	Product Categories	Warranty
Ethernet Switches	5 Years	DIN-Rail Power Supplies	3 Years
Wireless		Power Adaptors	1 Year
Serial Device Servers			
Modbus Gateways			
Media Converters			
Embedded Device Servers	Other Accessories		

The warranty certification will not be effective until an authorized stamp issued by ATOP's overseas agents.

Purchase Date: / / (yyyy/mm/dd)

Serial Number



ATOP Customer Services and Support

1. Contact your local dealers or ATOP Technical Support Center at the following number: +886-3-550-8137
2. Report any problems via ATOP's website or email
www.atoponline.com service@atop.com.tw

